



Floater

- › Innenleben wahlweise mit unterschiedlichen Elementen bestückbar: nur Kissen (Sitz-, Rücken- und Arml.-kissen)
- › Armlehnregal, Arbeitsregal, Eckregal und Mittelregal
- › 2- und 3-Sitzer mit hohem Rücken
- › Regale immer mit einer Stromsteckdose in weiß ausgestattet (1xSchuko und 1xUSB)
- › Holzarten für Beine, Holzleiste und Regale: Eiche natur geölt, Esche natur geölt und Eiche in anderen Lackfarben (offenporig lackiert)
- › Bezüge sind als Wechselbezüge gearbeitet und abnehmbar
- › Bezüge in Stoff oder Leder
- › Bezug in einem Design oder Korpus/Kissen unterschiedlich möglich
- › Polsterschäume optional schwer entflammbar nach BS5852
- › Wahlweise Kunststoff- oder Filzgleiter je nach Bodenbeschaffenheit (leichter Austausch durch Klicksystem)
- › Interior can be fitted optionally with different elements: only cushions (seat, back and armrest cushions)
- › Armrest shelf, work shelf, corner shelf and centre shelf
- › 2- and 3-seater with high back
- › Shelves always fitted with a power socket in white (1xSchuko and 1xUSB)
- › Wood types for legs, wooden slat and shelves: natural oiled oak, natural oiled ash and oak in other lacquered colours (open-pore lacquered)
- › Covers are made as exchangeable covers and removable
- › Covers in fabric or leather
- › Cover in one design or different body/cushion possible
- › Upholstery foam optionally flame retardant according to BS5852
- › Choice of plastic or felt glides depending on the condition of the floor (easy replacement with click system)

Spezifikationen

Specifications

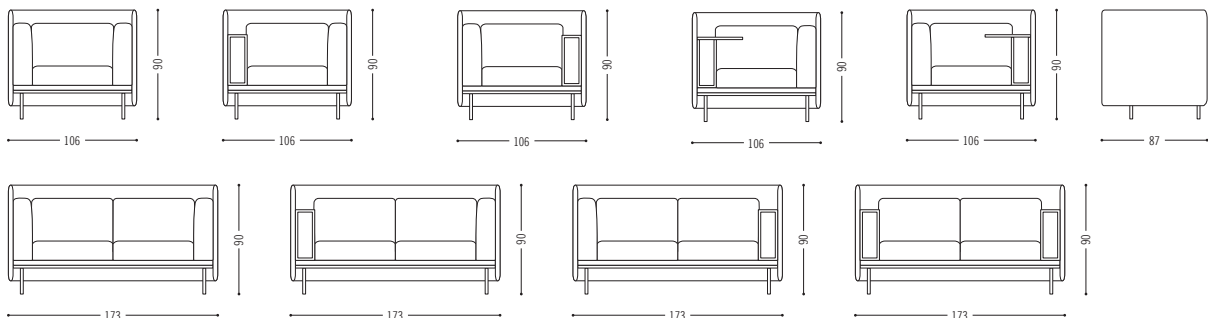



DESIGN: PAULINE DELTOUR

COR.DE/LAB

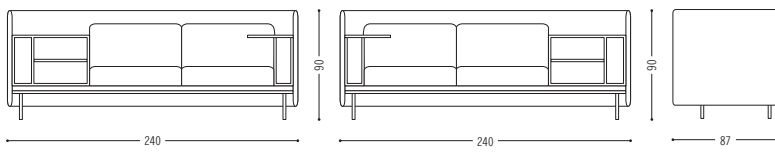
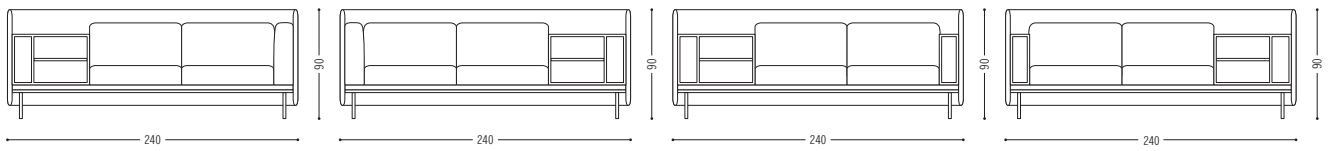
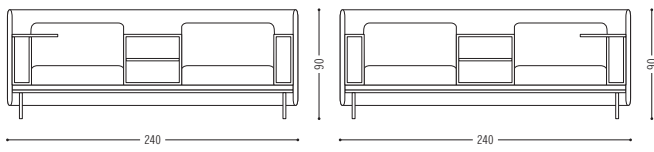
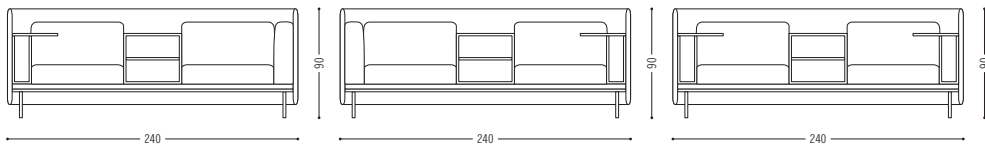
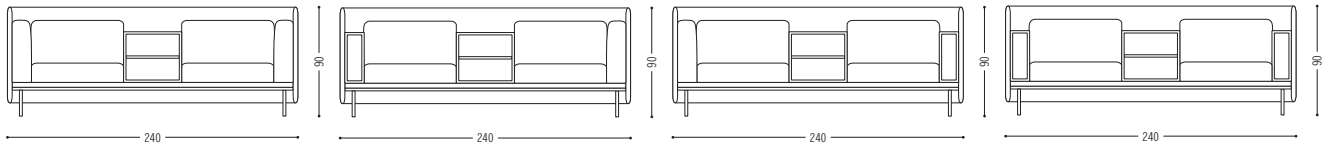
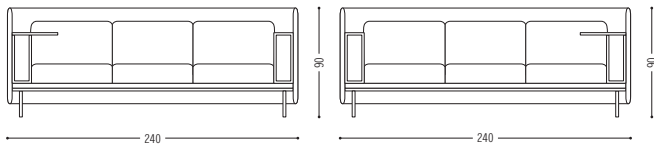
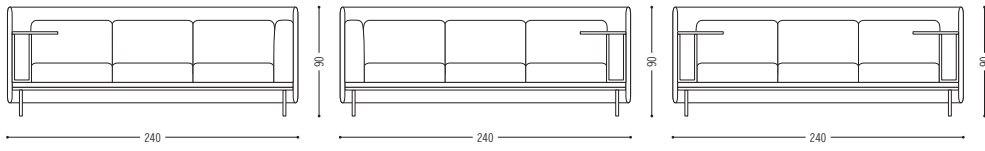
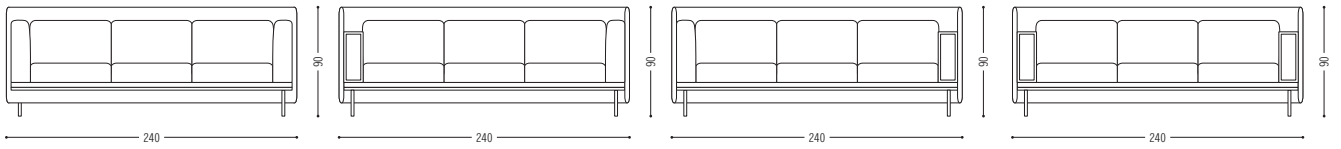
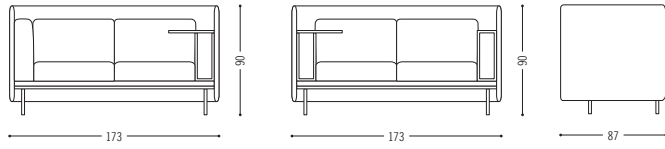
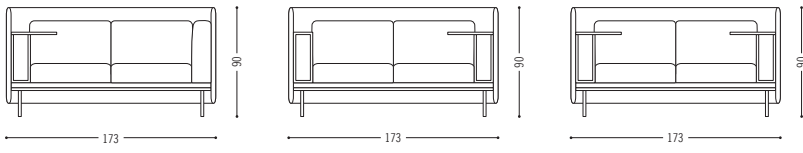



DESIGN: PAULINE DELTOUR

COR.DE/LAB

Mit hohem Rücken
with high back

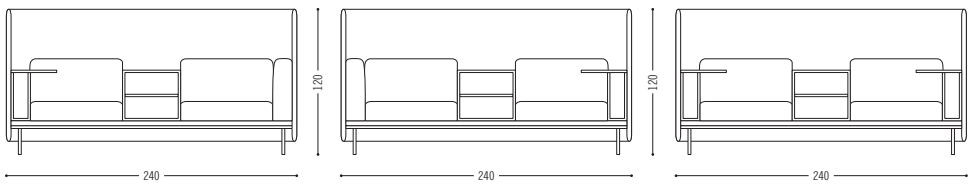
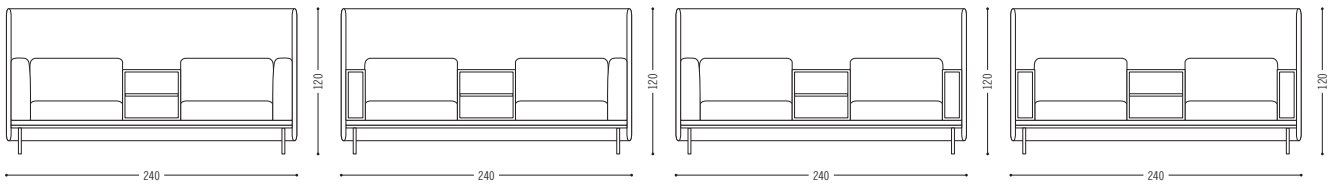
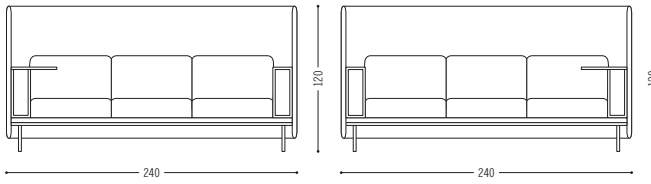
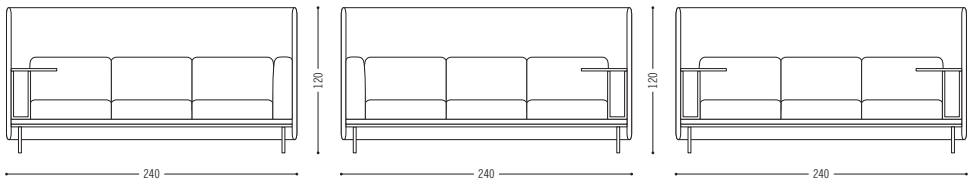
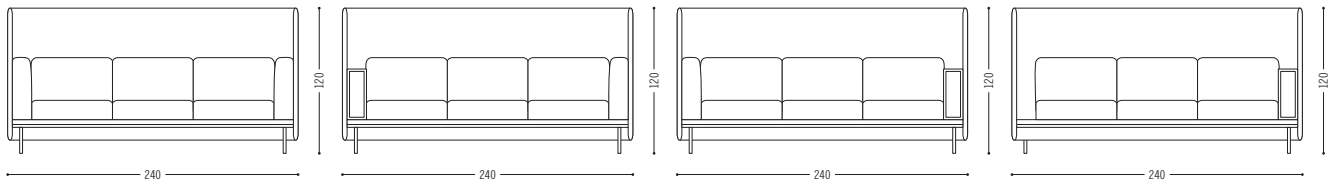
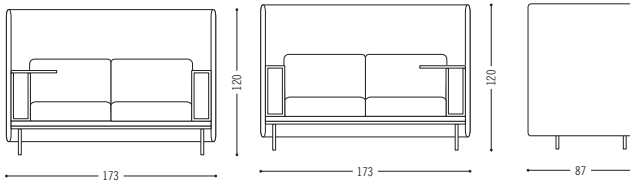
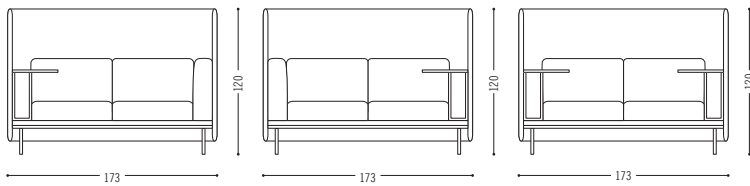
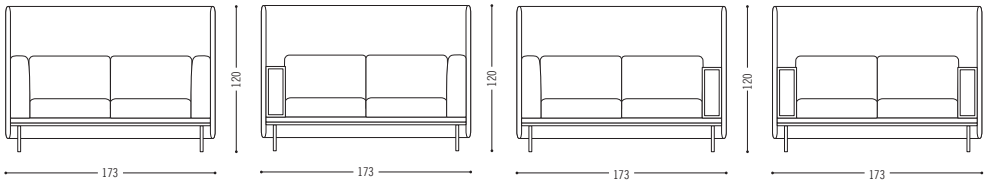
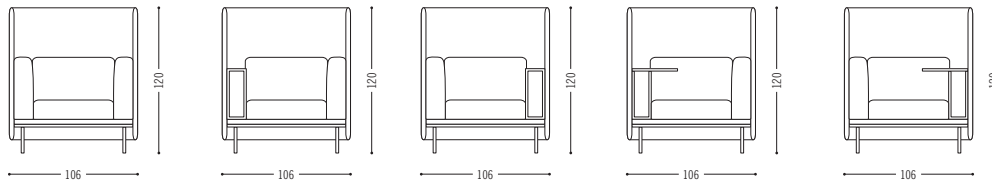



DESIGN: PAULINE DELTOUR

COR.DE/LAB

